



De'Longhi America, Inc.

Park 80 West, Plaza One
Saddle Brook, NJ 07663

1-866-528-8323 (1-866-Latte-Best)

De'Longhi Canada, Inc.

6150 McLaughlin Road
Mississauga, Ontario
L5R 4E1 Canada
1-888-335-6644

Fiducia Italiana S.A de C.V.

Pestalozzi 814
Col. Del Valle
Del. Benito Juarez
México D.F. 03100
tels: 5543 1447 y 5543 6492
Lada sin costo: 01800 711 8805

www.delonghi.com

Instructions for use. Keep these instructions
Mode d'emploi. Conservez cette notice
Instrucciones para el uso. Repase y guarde
estas instrucciones. Lea cuidadosamente este
instructivo antes de usar su aparato
Istruzioni per l'uso
Leggere e conservare queste istruzioni

**FULLY AUTOMATIC COFFEE CENTER
MACHINE À CAFÈ AUTOMATIQUE
CAFETERA SUPERAUTOMATICA
MACCHINA PER CAFFÈ SUPERAUTOMATICA
ESAM6700**



Register this product on-line and receive a free trial issue of Cook's Illustrated. Visit www.delonghiregistration.com. Visit www.delonghiousa.com for a list of service centers near you. (U.S. and Canada Only)

Registre este producto en línea y reciba un ejemplar gratis de Cook's Illustrated. Visite www.delonghiregistration.com. Visite www.delonghiousa.com para ver la lista de centros de servicios cercanos a usted. (Solamente en los Estados Unidos y Canadá)

Enregistrez ce produit en ligne et recevez un numéro gratuit de Cook's Illustrated. Visitez www.delonghiregistration.com. Visitez www.delonghiousa.com pour y voir une liste des centres de réparation proches de chez vous. (É.-U. et Canada uniquement)

Registra questo prodotto "on-line" per ricevere una copia omaggio della rivista Cook's Illustrated. Visita www.delonghiregistration.com. Visita www.delonghiousa.com per una lista dei centri di servizio a te più vicini. (Solo negli Stati Uniti e Canada)

Electronic Characteristics: Caractéristiques électriques: Características electricas: Caratteristiche elettriche:
120V~60HZ 1350W

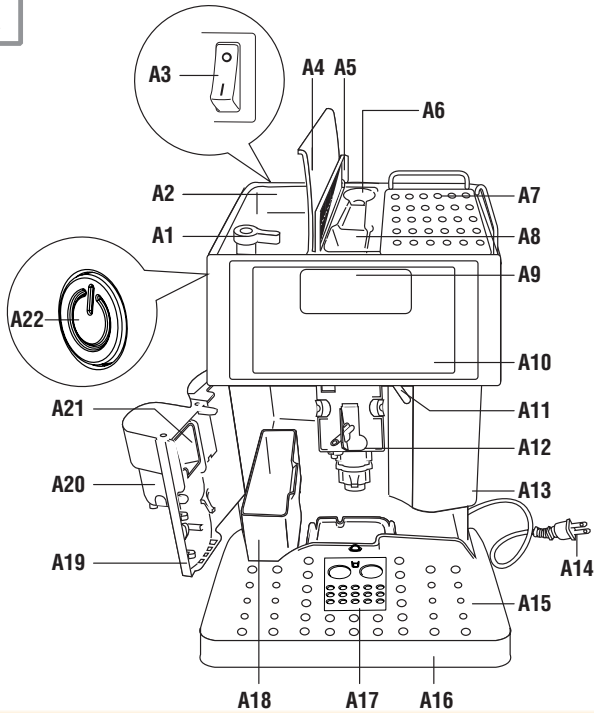
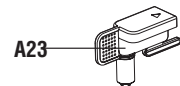
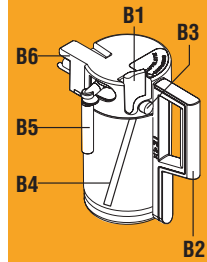
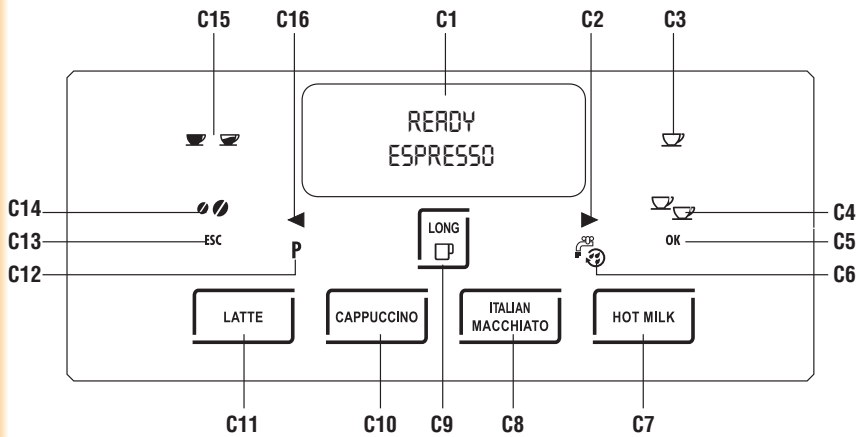
A**B****C**

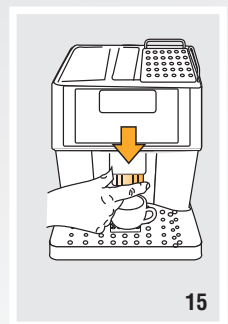
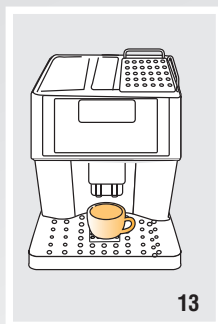
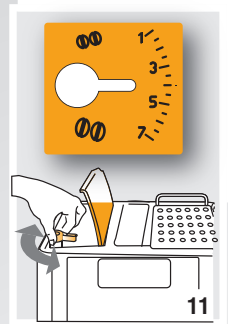
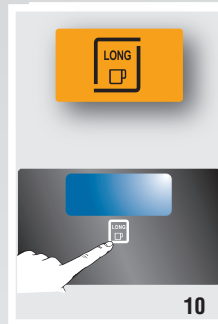
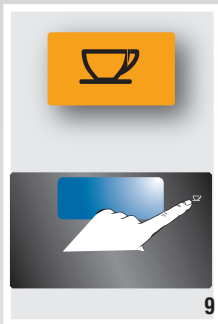
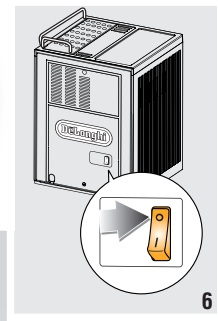
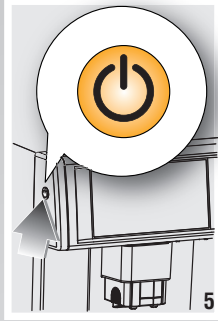
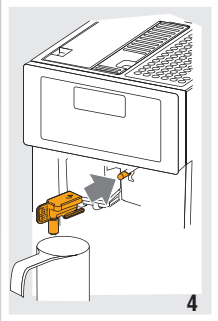
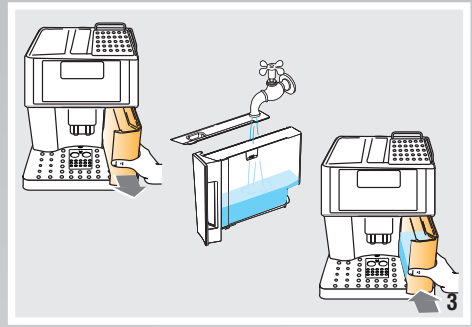
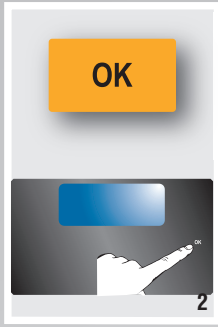
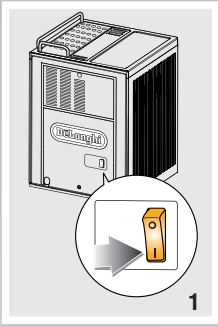

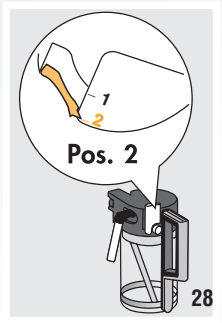
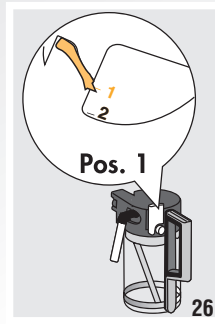
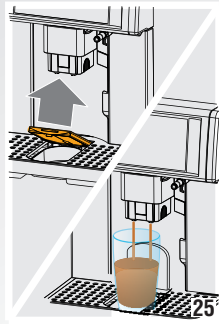
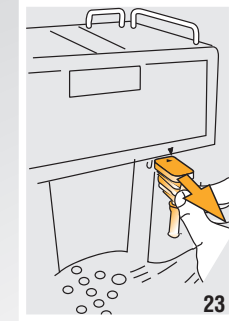
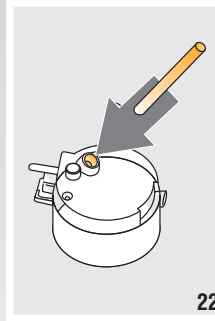
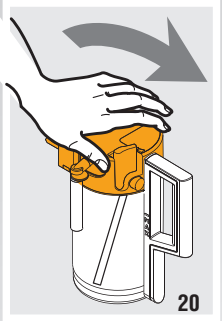
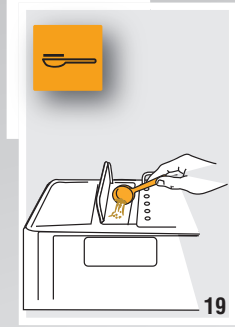
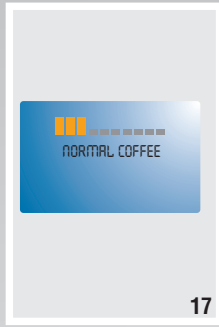

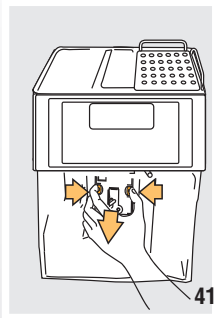
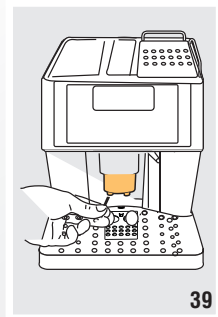
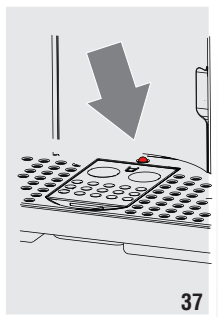
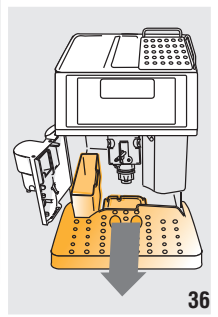
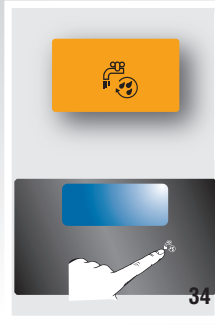

INDEX

IMPORTANT SAFEGUARDS	8
SHORT CORD INSTRUCTIONS	8
INTRODUCTION	9
Symbols used in these instructions	9
Letters in brackets	9
Troubleshooting and repairs	9
DESCRIPTION	9
Description of appliance	9
Description of milk container	9
Description of control panel (touch screen).....	9
PRELIMINARY CHECKS	10
Controls after transport.....	10
Installing the appliance	10
Connecting the appliance	10
Setting up the appliance.....	11
TURNING THE APPLIANCE ON	11
TURNING THE APPLIANCE OFF	11
CHANGING THE MENU SETTINGS	12
Setting the language	12
Setting the clock	12
Setting auto-start time	12
Setting the temperature	12
Setting auto-off	12
Resetting default values (reset)	13
Statistics function	13
Acoustic signal (Beep enabled).....	13
MAKING COFFEE	13
Selecting the coffee taste	13
Selecting the quantity of coffee in the cup	13
ESPRESSO (oz)	13
LONG COFFEE (oz).....	13
Programming the espresso “my coffee” quantity	13
Programming the long “my coffee” quantity..	14
Regulating the coffee mill	14
Making espresso coffee using coffee beans...	14
Making long coffee using coffee beans.....	14
Making espresso or long coffee using pre-ground coffee	15
MAKING DRINKS WITH MILK	15
Filling and attaching the milk container.....	15
Making latte	15
Making cappuccino	16
Making Italian macchiato	16
Making hot milk	16
Cleaning the milk container after use	16
Programming the size for each beverage button	16
HOT WATER	17
Preparation	17
Changing the quantity	17
CLEANING	17
Cleaning the coffee maker	17
Cleaning the coffee grounds container.....	17
Cleaning the drip tray	18
Cleaning the water tank.....	18
Cleaning the coffee nozzles.....	18
Cleaning the pre-ground coffee feed funnel ...	18
Cleaning the inside of the machine	18
Cleaning the brew group	18
Cleaning the milk container.....	19
DESCALING	19
SETTING WATER HARDNESS	20
Measuring water hardness.....	20
Setting water hardness	20
USING COMPARTMENT FOR LATTE GLASS 20	
DISPLAYED MESSAGES	21
TROUBLESHOOTING	22
LIMITED WARRANTY	24

IMPORTANT SAFEGUARDS

When using electrical appliances, basic safety precautions should always be followed, including the following.

- Read all instructions carefully.
- Make sure the voltage of your electrical system corresponds to the voltage shown on the bottom of the machine.
- Do not touch hot surfaces. Use handles or knobs.
- To protect against fire, electrical shock and personal injury, do not immerse cord, plug or appliance in water or other liquid.
- Keep the appliance out of the reach of children and do not leave appliance unattended while in operation.
- Unplug from the outlet when not in use and before cleaning.
- Do not operate with a damaged cord or plug, or after the appliance malfunctions, or has been damaged in any manner. Return the appliance to the nearest authorized service facility for examination, repair or adjustment.
- The use of accessory attachments not recommended by the manufacturer may result in fire, electrical shock, or personal injury.
- Do not use outdoors.
- Make sure the power cord does not hang over the edge of the table or counter-top to avoid getting accidentally caught or entangled.
- Do not place the appliance or its electrical parts on or near electric stoves, cooking surfaces, or gas burners.
- Plug cord into the wall outlet. To disconnect, first turn machine “off”, then remove plug from wall outlet.
- Do not use the appliance for other than the intended use. This appliance is to be utilized for domestic use only. The manufacturer declines all responsibility for any damage caused by improper, incorrect, or irresponsible use.

WARNING: To reduce the risk of fire or electric shock, do not remove the cover or the exterior of the unit. Don't attempt to repair or modify the machine, doing so will void the warranty. Repair should be done by authorized service personnel only!

SAVE THESE INSTRUCTIONS

THIS APPLIANCE IS FOR HOUSEHOLD USE ONLY

SHORT CORD INSTRUCTIONS

A short power cord is provided to reduce risks resulting from becoming entangled in or tripping over a longer cord.

- Longer, detachable power supply cords or extension cords are available and may be used if care is exercised in their use.
- If an extension cord is used, the marked electrical rating should be at least as great as the electrical rating of the appliance. If the appliance is provided with 3- wire, grounding type cord, the extension should be a GROUNDING TYPE 3 - WIRE CORD. The longer cord should be arranged so that it will not drape over the counter-top or table top where it can be pulled on by children or tripped over.
- Your product is equipped with a polarized alternating current line plug (a plug having one blade wider than the other). This plug will fit into the power outlet only one way. This is a safety feature. If you are unable to insert the plug fully into the outlet, try reversing the plug. If the plug should still fail to fit, contact your electrician to replace your obsolete outlet. Do not defeat the safety purpose of the polarized plug.

INTRODUCTION

Thank you for choosing the ESAM 6700 automatic coffee and cappuccino maker.

We hope you enjoy using your new appliance.

Take a few minutes to read these instructions.

This will avoid all risks and damage to the machine.

Symbols used in these instructions

Important warnings are identified by these symbols.

These warnings must absolutely be respected.



Danger!

Failure to observe the warning could result in possibly life threatening injury from electric shock.



Important!

Failure to observe the warning could result in injury or damage to the appliance.



Danger Of burns!

Failure to observe the warning could result in scalds or burns.



Information :

This symbol identifies important advice or information for the user. .

Letters in brackets

The letters in brackets refer to the legend in the description of the appliance on page 3.

Troubleshooting and repairs

In the event of problems, first try and resolve them following the information given in the sections “Displayed messages” on page 21 and “Troubleshooting” on page 23.

If this does not resolve the problem or you require further information, you should consult Customer Service by calling the number given on the “Customer Service” sheet.

If your country is not among those listed on the sheet, call the number given in the guarantee.

If repairs are required, contact De’Longhi customer services only.

The addresses are given in the warranty certificate provided with the machine.

DESCRIPTION

Description of appliance

(page 3 - **A**)

- A1. Grinding coarseness regulator knob
- A2. Container for coffee beans
- A3. Main switch (some models only)
- A4. Bean container lid
- A5. Cover for pre-ground coffee funnel
- A6. Measuring scoop compartment
- A7. Cup warmer shelf
- A8. Ground coffee funnel
- A9. Display
- A10. Touch screen (control panel)
- A11. Hot water and steam nozzle
- A12. Brew group
- A13. Water tank
- A14. Power cable
- A15. Cup tray
- A16. Drip tray
- A17. Compartment for latte glass
- A18. Grounds tray
- A19. Service door
- A20. Coffee spout (adjustable height)
- A21. Coffee guide
- A22. ON/STAND-BY button
- A23. Hot water spout
- A24. Coffee scoop

Description of milk container

(page 3 - **B**)

- B1. Milk frother selector
- B2. Milk container handle
- B3. CLEAN button
- B4. Milk intake tube
- B5. Frothed milk spout
- B6. Lid for milk frother

Description of control panel (touch screen)

(page 3 - **C**)



Information: Only the icons relating to the controls enabled for the particular function currently being used will be lit on the touch screen.

- C1. Display: guides the user in using the appliance.
- C2. ► : icon: to scroll forwards through the programming menu.
- C3. ☕ icon: to deliver one cup of espresso coffee.
- C4. ☕ icon: to deliver one cup of espresso

coffee.

- C5. **OK** icon: to enable and confirm the selected function.
- C6.  icon: to rinse or deliver hot water.
- C7. **HOT MILK** icon: to deliver a cup of steamed milk.
- C8. **ITALIAN MACCHIATO** icon: to deliver a shot of espresso with a small amount of foam on top.
- C9. **LONG**  icon: to deliver one cup of
- C10. **CAPPUCCINO** icon: to deliver a cappuccino.
- C11. **LATTE** icon: to deliver a latte.
- C12. **P** icon: to access the programming menu.
- C13. **ESC** icon: to exit the selected function in the menu.
- C14.  icon: to select the coffee's strength.
- C15.  icon: to select the coffee size.
- C16.  icon: to scroll backwards through the programming menu.

 **Information** : A light touch is enough to activate the icon.

PRELIMINARY CHECKS

Controls after transport

After removing the packaging, make sure the product is complete and undamaged and that all accessories are present.

Do not use the appliance if it is visibly damaged.

Contact Customer Service.

Installing the appliance

Important!

When you install the appliance, you should follow the safety warnings below:

- The appliance gives off heat. After positioning the appliance on the work top, leave a space of at least 1 in (3 cm) between the appliance and the side and rear walls and at least 6 in (15 cm) above the coffee maker.
- Water penetrating the appliance could cause damage. Do not place the appliance near taps or sinks.
- The appliance could be damaged if the water it contains freezes. Do not install the appliance in a room where the temperature could drop below freezing point.
- Arrange the power cable in such a way that it cannot be damaged by sharp edges or contact with hot surfaces (e.g. electric hot plates).

Connecting the appliance

 **Important!** Check that the power outlet supply voltage corresponds to the value indicated on the rating plate on the bottom of the appliance.

Connect the appliance to an efficiently earthed and correctly installed outlet with a minimum current rating of 12A only. If the power outlet does not match the plug on the appliance, have the outlet replaced with a suitable type by a qualified professional.

Setting up the appliance

Information :

- Coffee has been used to factory test the appliance and it is therefore completely normal for there to be traces of coffee in the mill.

The machine is, however, guaranteed to be new.

- You should customize water hardness as soon as possible following the instructions in the section “Setting water hardness” on page 20.

1. Plug the appliance into the power outlet and (in models provided with main switch) place the main switch on the back of the appliance in the I position (fig. 1).

You must first select the language (the languages scroll through at intervals of about two seconds):

2. When English appears, press the **OK** icon for 3 seconds (fig. 2). Once the language has been saved, the message “English installed” is displayed.

Follow the instructions indicated by the appliance:

3. “FILL TANK!”: remove the water tank, fill to the MAX line with fresh water then replace in the appliance (fig. 3).

4. “INSERT WATER SPOUT AND PRESS OK”: Check that the hot water spout is inserted on the nozzle and place a container underneath (fig. 4).

Press the **OK** icon (fig. 2). “PLEASE WAIT...” is displayed and the appliance begins to deliver hot water.

The appliance ends the first start up procedure, then the message “Turning off, please wait...” is displayed and the appliance goes off.

The coffee maker is now ready for normal use.

 **Information:** When using the appliance for the first time, you need to make 4-5 cups of coffee and 4-5 cappuccinos before the appliance starts to give satisfactory results.

TURNING THE APPLIANCE ON

 **Information:** In models provided with main switch, before turning the appliance on, make sure the main switch on the back of the appliance is in the I position (fig. 1).

Each time the appliance is turned on, it performs an automatic preheat and rinse cycle which cannot be interrupted.

The appliance is ready for use only after completion of this cycle.

 **Danger of burns!** During rinsing, a little hot water comes out of the coffee spouts and is collected in the drip tray underneath. Avoid contact with splashes of water.

- To turn the appliance on, press the button on the left side of the machine  (fig. 5): the message “Heating up... please wait” is displayed.

When heating is complete, the message changes to: “Rinsing”. As well as heating the boiler, this also heats the internal circuits by circulating hot water.

The appliance is at temperature when the message “STANDARD COFFEE standard taste” is displayed.

TURNING THE APPLIANCE OFF

Each time the appliance is turned off, it performs an automatic rinse cycle which cannot be interrupted.

 **Danger of burns!** During rinsing, a little hot water flows from the coffee spouts. Avoid contact with splashes of water.

To turn the appliance off, press the  button (fig. 5). The appliance performs the rinse cycle then goes off.

 **Information:** In models provided with main switch, if the appliance is not used for an extended period, place the main switch on the back of the appliance in the 0 position (fig. 6).

CHANGING THE MENU SETTINGS

Setting the language

To modify the language on the display, proceed as follows:

1. Press the **P** icon to enter the programming menu;
2. Press the ◀ or ▶ icon until “Set language” is displayed;
3. Press the **OK** icon;
4. Press the ◀ or ▶ icon until the required language is displayed;
5. Press the **OK** icon to confirm (or the **ESC** icon to cancel the operation);
6. Press the **ESC** icon to exit the menu.

Setting the clock

To adjust the time on the display, proceed as follows:

1. Press the **P** icon to enter the programming menu;
2. Press the ◀ or ▶ icon until “Adjust time” is displayed;
3. Press the **OK** icon: the hours flash on the display;
4. Press the ◀ or ▶ icon to change the hours;
5. Press the **OK** icon to confirm (or the **ESC** icon to cancel the operation): the minutes flash on the display;
6. Press the ◀ or ▶ icon to change the minutes;
7. Press the **OK** icon to confirm (or the **ESC** icon to cancel the operation);
8. Press the **ESC** icon to exit the programming menu.

Setting auto-start time

You can set the auto-start time in order to have the appliance ready at a certain time (for example in the morning) so you can make coffee immediately.

1. Press the **P** icon to enter the programming menu;
2. Press the ◀ or ▶ icon until “Auto-start disabled” is displayed; “Enable?” is displayed and the hours flash on the display;
3. Press the **OK** icon: the hours flash on the display;
4. Press the ◀ or ▶ icon to change the hours;

5. Press the **OK** icon to confirm: the minutes flash on the display;
6. Press the ◀ or ▶ icon to change the minutes;
7. Press the **OK** icon to confirm: “Auto-start Enabled?” is displayed;
8. Press the **ESC** icon to exit the menu: a symbol  appears next to the clock to indicate that auto-start has been programmed.

To deactivate the function:

1. Press the **P** icon to enter the programming menu;
2. Press the ◀ or ▶ icon until “Auto-start Enabled?” is displayed;
3. Press the **OK** icon: the hours flash on the display;
4. Press the **ESC** icon. This deactivates the function and the  symbol disappears from the display.
5. Press the **ESC** icon to exit the menu.

 **Information** : To activate this function, the time must have been set previously.

Setting the temperature

To modify the temperature (low, medium, high) of the water used to make the coffee, proceed as follows:

1. Press the **P** icon to enter the menu;
2. Press the ◀ or ▶ icon until “Temperature” is displayed;
3. Press the **OK** icon;
4. Press the ◀ or ▶ icon until the required temperature (low, medium or high) is displayed;
5. Press the **OK** icon to confirm (or the **ESC** icon to cancel the operation);
6. Press the **ESC** icon to exit the menu.

Setting auto-off

 **Information**: The appliance is set to switch automatically to stand-by if not used for 30 minutes. The time can be changed so that the appliance switches off after 1 or 2 hours.

1. Press the **P** icon to enter the menu;
2. Press the ◀ or ▶ icon until “Auto-off” is displayed;
3. Press the **OK** icon;
4. Press the ◀ or ▶ icon until the required

number of hours of operation (30 minutes, 1 or 2 hours) is displayed;

5. Press the **OK** icon to confirm (or the **ESC** icon to cancel the operation);
6. Press the **ESC** icon to exit the menu.

Resetting default values (reset)

This resets all menu settings and programmed quantities back to the default values (with the exception of the language, time and beep which remains as set as well as the counter for the statistics function).

1. Press the **P** icon to enter the menu;
2. Press the ◀ or ▶ icon until “Default values” is displayed;
3. Press the **OK** icon;
4. The message “Confirm?” is displayed.
5. Press the **OK** icon to confirm and exit (or the **ESC** icon to cancel the operation).

Statistics function

This displays statistics relating to the machine. To display, proceed as follows:

1. Press the **P** icon to enter the menu;
2. Press the ◀ or ▶ icon until “Statistics” is displayed;
3. Press the **OK** icon;
4. By pressing the ◀ or ▶ icon, you can check:
 - how many coffees have been made;
 - how many drinks with milk have been made;
 - how many times the machine has been descaled;
 - the total number of liters of water delivered;
5. Press the **ESC** icon twice to exit the menu.

Acoustic signal (Beep enabled)

This activates or deactivates the beep emitted by the machine each time an icon is pressed or an accessory is inserted/removed. The beep is enabled by default.

1. Press the **P** icon to enter the menu;
2. Press the ◀ or ▶ icon until “Beep enabled” is displayed;
3. Press the **OK** icon to confirm, “Confirm?” is displayed;
4. Press the **OK** icon again to confirm activation or the **ESC** icon to deactivate the function;
5. Press the **ESC** icon to exit the menu.

i Information : The descale and water hardness functions will be explained later in the manual.

MAKING COFFEE

Selecting the coffee taste

The appliance is preset to make coffee with a standard taste.

You can choose between 5 different coffee tastes:

- Extra-mild taste
- Mild taste
- Standard taste
- Strong taste
- Extra-strong taste

To change the flavor, press the  icon (fig. 7) repeatedly until the required taste is displayed.

Selecting the quantity of coffee in the cup



To select the quantity of coffee, press the  icon repeatedly (fig. 8) until the required quantity of coffee is displayed. The quantities delivered are different according to the type of coffee selected:

	ESPRESSO (oz)	LONG COFFEE (oz)
MY COFFEE	max: ≈6	max: ≈ 8.5
SHORT COFFEE	≈1.4	≈ 4.2
STANDARD COFFEE	≈ 2	≈ 6
LONG COFFEE	≈ 3	≈ 7
EXTRA LONG COFFEE	≈ 4	≈ 8.5

Programming the espresso “my coffee” quantity

The appliance is set by default to automatically deliver 1 oz of espresso coffee.

To modify this quantity, proceed as follows:

1. Press the  icon repeatedly (fig. 8) until “MY COFFEE” is displayed.
2. Press and hold the one cup  icon (fig. 9) for about 8 seconds until “Program quantity” is displayed, then release. The machine starts delivering the coffee and the  icon flashes;
3. As soon as the coffee in the cup reaches the

required level, press the ☞ icon again.
The quantity set has now been programmed.

i Information: This setting is valid for making both one and two cups. You cannot program a quantity for two cups. To obtain 2 quantities of “my coffee” press the ☞ button.

Programming the long “my coffee” quantity

The appliance is set by default to automatically deliver ≈ 3.4 oz of LONG coffee. To modify this quantity, proceed as follows:

1. Press the ☞ icon repeatedly (fig. 8) until “MY COFFEE” is displayed.
2. Press the **LONG** ☐ icon (fig. 10) until “Program quantity” is displayed, then release. The machine starts delivering the coffee and the **LONG** icon flashes.
3. As soon as the coffee in the cup reaches the required level, press the **LONG** icon again.

The quantity set has now been programmed.

Regulating the coffee mill

The coffee mill is preset in the factory to prepare coffee correctly and should not require regulating initially.

However, if after making the first few coffees you find that delivery is either too fast or too slow (a drop at a time), this can be corrected by regulating the grinding adjustment knob (fig. 11).

! Important! The grinding coarseness regulator must only be turned when the coffee mill is in operation (when you hear the grinder in motion).

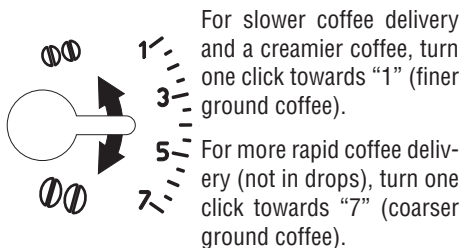

i Information: These adjustments will only be evident after at least two cups of coffee have been made.

Making espresso coffee using coffee beans

! Important! Do not use caramelized or candied coffee beans as they could stick to the coffee mill and make it unusable.

1. Fill the container with coffee beans (fig. 12).
2. Place under the coffee spouts:
 - one cup, if you want one coffee (fig. 13);
 - two cups, if you want two coffees (fig. 14);
3. Lower the spouts as near as possible to the cup. This makes a creamier coffee (fig. 15).
4. Choose the strength by hitting the ☐ and size by hitting the ☞.
5. Press the icon corresponding to the number of coffees required (one cup ☞ or two cups ☞) (fig. 9 and 16).
6. Preparation begins. A progress bar appears on the display and gradually advances as the procedure progresses (fig. 17).

Once the coffee has been made, the appliance is ready to use again.

i Information:

- While the machine is making coffee, delivery can be interrupted at any moment by pressing the lit cup icon.
- For a hotter coffee, before delivery rinse the appliance through by pressing the ☞ icon and confirming with the OK icon. Hot water flows out of the coffee spouts and heats the internal circuit of the machine so that the coffee delivered will be hotter.
- For an even hotter coffee, heat the cups by rinsing them with the hot water.
- If the coffee is delivered in drops, too fast and not creamy enough or too cold, read the tips in the “Troubleshooting” section on page 22.

Making long coffee using coffee beans

i Information: When this function is activated, a long coffee similar to drip coffee is obtained.

! Important! Do not use caramelized or candied coffee beans as they could stick to the coffee mill and make it unusable.

1. Fill the container with coffee beans (fig. 12).
2. Adjust the height of the spout according to

the cup used. Put the cup for long coffee under the spouts (fig. 18);

3. Choose the strength by hitting the  and size by hitting the .
4. Press the **LONG** icon (fig. 10). Preparation begins. A progress bar appears on the display and gradually advances as the procedure progresses.

 **Information:**



- While the machine is making coffee, delivery can be interrupted at any moment by pressing the **LONG** icon.
- Only one cup of long coffee can be made at a time.
- When delivering more than 4.2 oz, the appliance automatically grinds more coffee halfway through delivery.

Making espresso or long coffee using pre-ground coffee

 **Important!**

- Never add pre-ground coffee when the machine is off or it could spread through the inside of the machine and dirty it.
- Never use more than one level measuring scoop or it could dirty the inside of the machine or block the funnel.

 **Information:** If you use pre-ground coffee, you can only make one cup of coffee at a time.

1. Press the  icon repeatedly (fig. 7) until “Pre-ground” flashes on the display.
2. Put one level measuring scoop of pre-ground coffee into the funnel (fig. 19).
3. Place a cup under the coffee spouts.
4. To make espresso coffee, press the one cup  icon (fig. 9). To make a long coffee, press the **LONG** icon (fig. 10).

 **Information: LONG COFFEE:** when delivering more than 4.2 oz, the appliance requests a new level measure of pre-ground coffee halfway through delivery. When you have added the pre-ground coffee, confirm by pressing the **OK** icon.

MAKING DRINKS WITH MILK

Filling and attaching the milk container



1. Turn the lid of the milk container clockwise until it becomes noticeably difficult to turn, then remove the lid (fig. 20).
2. Fill the milk container with a sufficient quantity of milk, not exceeding the MAX level marked on the handle (fig. 21).

 **Information!** We recommend using skim or 2% milk at refrigerator temperature (about 41°F). To avoid milk with poor froth or large bubbles, always clean the milk lid and hot water nozzle as described in the section “Cleaning the milk container” on page 19.

3. Make sure the milk intake tube is correctly inserted in the bottom of the milk container lid (fig. 22).
4. Replace the milk container lid and turn counterclockwise as far as it will go until you hear it click.
5. Remove the hot water spout from the nozzle (fig. 23).
6. Attach the container to the nozzle and push as far as it will go (fig. 24). The machine emits a beep when milk container is attached correctly (if the beep function is enabled).
7. Place a sufficiently large cup under the coffee spouts and frothed milk spout.
To use particularly tall cups/glasses, raise the lid (A17) of the special compartment in the cup tray (fig. 25).

Making latte

1. After attaching the milk container, place frothed milk regulator (B1) on lid to position 1 for LATTE (fig. 26).
2. Press the **LATTE** icon (fig. 27).
The message “Caffelatte... Jug selector in position: 1” appears. After a few seconds, frothed milk is delivered from the milk spout into the cup below. The milk will stop automatically and delivery of coffee will begin.

 **Information:** If during delivery you want to stop preparing milk, press the **LATTE** icon or interrupt preparation of the coffee by pressing the  icon.

Making cappuccino

1. After attaching the milk container, place frothed milk regulator (B1) on lid to position 2 for CAPPUCCINO (fig. 28). **The quantity of froth can be adjusted by moving the regulator towards number 2 for a denser froth.**

Moving it towards number 1 obtains a less dense froth.

2. Press the **CAPPUCCINO** icon (fig. 29). The message “Cappuccino... Jug selector in position: 2” appears. After a few seconds, frothed milk flows out of the milk spout into the cup below.

The milk will stop automatically and delivery of coffee will begin.

i Information! If during delivery you want to stop preparing milk, press the **CAPPUCCINO** icon or interrupt preparation of the coffee by pressing the  icon.

Making Italian macchiato

1. After attaching the milk container, place frothed milk regulator (B1) on lid to position 2 for ITALIAN MACCHIATO (fig. 28)
2. Press the **ITALIAN MACCHIATO** icon (fig. 30). The message “Macchiato... Jug selector in position: 2” appears.

After a few seconds, frothed milk flows out of the milk spout into the cup below.

The milk will stop automatically and delivery of coffee will begin.

i Information: If during delivery you want to stop preparing milk, press the **ITALIAN MACCHIATO** icon or interrupt preparation of the coffee by pressing the  icon.

Making hot milk

1. After attaching the milk container, position the frothed milk regulator (B1) according to the quantity of froth you require (pos. 1 = little froth; pos. 2 = abundant froth).
2. Press the **HOT MILK** icon (fig. 31). “HOT MILK” appears on the display and after a few seconds, frothed milk is delivered from the milk spout into the cup below. Delivery of milk stops automatically.

i Information: If during delivery you want to stop preparing milk, press the **HOT MILK** icon once.

Cleaning the milk container after use

! Important! Danger of burns When cleaning the internal tubes of the milk container, a little hot water comes out of the frothed milk tube (B5). Avoid contact with splashes of water.

When “Press CLEAN button” flashes on the display (each time you use a milk function):

1. Leave the jug attached to the machine (you do not need to empty it);
2. Place a cup or other recipient under the frothed milk spout.
3. Press the CLEAN button (fig. 32) and keep pressing until the progress bar which appears on the display together with the message “Cleaning...” is complete.
4. Remove the milk container and always clean the nozzle with a sponge (fig. 33).

i Information!

- When “Press CLEAN button” flashes on the display, you can still prepare any type of coffee or milk. If you have to make a number of drinks with milk, wait until you have delivered the last cup before cleaning the container.
- The milk left in the jug can be kept in the refrigerator.

Programming the size for each beverage button

The appliance is factory preset to automatically deliver standard quantities.

To change these quantities, proceed as follows:

1. Place a cup under the coffee spouts and milk spout.
2. Press the icon corresponding to the function you want to program (LATTE, CAPPUCCINO, ITALIAN MACCHIATO or HOT MILK) until “Milk for... Program quantity” appears on the display and the icon corresponding to the selected function flashes.
3. Release the icon. The appliance starts delivering milk.
4. When the required quantity of milk has been delivered into the cup, press the icon again.
5. After a few seconds, the appliance starts delivering coffee into the cup and the message “Coffee for... Program quantity” is displayed (with the exception of the HOT MILK function) and the  icon flashes.



6. As soon as the coffee in the cup reaches the required level, press the  icon. Coffee delivery stops.

The machine is now reprogrammed with the new quantities.

HOT WATER

Preparation



 **Important! Danger of burns.** Never leave the machine unsupervised while delivering hot water. The hot water spout becomes hot while water is being delivered and must be held by the handle only.

1. Make sure the hot water spout is attached correctly (fig. 4).
2. Place a container under the spout (as close as possible to avoid splashes).
3. Press the  icon (fig. 34). The message “Rinsing” “Hot water...” is displayed.
4. Press the  icon to select the “Hot water...” function (the selected message flashes on the display) and confirm the selection by pressing the **OK** icon (or cancel the selection by pressing the **ESC** icon).
5. Water flows out of the spout. Delivery stops automatically after 8.5 oz (250ml).
6. To interrupt delivery of hot water manually, press the  icon again.

 **Important!** You should not deliver hot water for more than two minutes at a time.

Changing the quantity

The appliance is factory preset to automatically deliver 8.5 oz (250ml). To modify these quantities, proceed as follows:

1. Position a container under the spouts.
2. Once the “Hot water” function has been selected, press and hold the OK icon (about 8 seconds) until “Hot water Program quantity” appears and the  icon flashes.
- When the hot water in the cup reaches the required level, press the  icon again.

The machine is now reprogrammed with the new quantity.

CLEANING

Cleaning the coffee maker

The following parts of the appliance must be cleaned regularly:

- coffee grounds container (A18),
- drip tray (A16),
- water tank (A13),
- coffee spouts (A20) and hot water nozzle (A11),
- pre-ground coffee feed funnel (A8),
- inside the machine, accessible after opening the service door (A19),
- brew group (A12),
- milk container (B)
- control panel (C)

Important!

- Do not use solvents, abrasive detergents or alcohol to clean the coffee maker. With De'Longhi superautomatic coffee makers, you need not use chemical products to clean the machine. The descaler recommended by De'Longhi is made from natural and completely biodegradable substances.
- None of the components of the appliance can be washed in a dishwasher with the exception of the milk container (B).
- Do not use metal objects to remove encrustations or coffee deposits as they could scratch metal or plastic surfaces.

Cleaning the coffee grounds container

When “EMPTY GROUNDS CONTAINER” is displayed, the grounds container must be emptied and cleaned. Until the grounds container has been cleaned, the appliance continues to display the message and coffee cannot be made.

To clean:

- open the service door on the front of the appliance (fig. 35), extract the drip tray (fig. 36), empty and clean.
- Empty the grounds container (A18) and clean thoroughly to remove all residues left on the bottom.

 **Important!** when removing the drip tray, the grounds container must be emptied, even if it is not completely full.

If this is not done, when you make the next coffees, the grounds container may fill up more than expected and clog the machine.

Cleaning the drip tray

⚠ Important! If the drip tray is not emptied regularly, the water could overflow from the edge and seep inside or around the machine. This could damage the machine, the surface it rests on or the surrounding area.

The drip tray is fitted with a level indicator (red) showing the level of water it contains (fig. 37). Before the indicator protrudes from the cup tray, the drip tray must be emptied and cleaned.

To remove the tray:

1. Open the service door (fig. 35);
2. Remove the drip tray and the grounds container (Fig. 36);
3. Empty the drip tray and grounds container (A18) and wash them;
4. Replace the drip tray complete with grounds container (A18);
5. Close the service door.

Cleaning the water tank

1. Clean the water tank (A13) regularly (about once a month) with a damp cloth and a little mild dish soap.
2. Clean to remove all soap residues, then rinse the water tank thoroughly.

Cleaning the coffee nozzles

1. Clean the nozzle periodically using a sponge or cloth (fig. 38).
2. Check regularly that the holes in the coffee spout are not blocked.
If necessary, remove coffee deposits with a toothpick (fig. 39).

Cleaning the pre-ground coffee feed funnel

- Check regularly (about once a month) that the pre-ground coffee funnel is not blocked.
If necessary, remove coffee deposits with a dull knife.

⚡ Danger of electric shock! Before performing any cleaning operations, the machine must be turned off and disconnected from the main power supply. Never immerse the coffee maker in water.

Cleaning the inside of the machine

1. Check regularly (about once a week) that the inside of the machine is not dirty. If necessary, remove coffee deposits with a dull knife and sponge.
2. Remove the residues with a vacuum cleaner (fig. 40).

Cleaning the brew group

The brew group must be cleaned at least once a month.

⚠ Important! The brew group (A8) must not be removed when the appliance is on. Do not attempt to use force to remove the brew group as this could damage the machine.

1. Make sure the machine is correctly turned off (see Turning off, page 31).
2. Open the service door (fig. 35);
3. Remove the drip tray and grounds container (fig. 36);
4. Press the two red release buttons inwards and at the same time pull the brew group outwards (fig. 41).

⚠ Important! Do not use detergents or liquid soap to clean the brew group. The detergent would remove the lubricant applied to the inside of the piston, causing the brew group to seize up and become unusable.

5. Soak the brew group in water for about 5 minutes, then rinse under the tap.
6. After cleaning, replace the brew group by sliding it onto the internal support and pin at the bottom, then push the PUSH symbol fully in until it clicks into place.

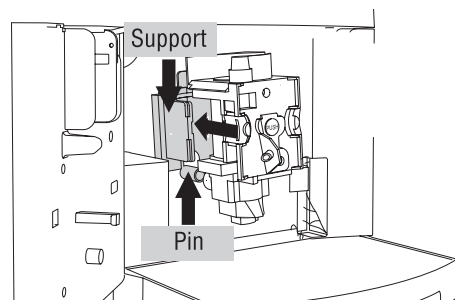

i Information!

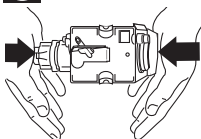

If the brew group is difficult to insert, you must first adapt it to the right dimension by pressing it forcefully from the bottom and top as shown in the figure.

7. Once inserted, make sure the two red buttons have snapped out.
8. Replace the drip tray and grounds container.
9. Close the service door.

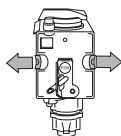

Cleaning the milk container

Clean the milk container each time you prepare milk as described below:

1. Remove the milk spout and intake tube.
2. Remove the selector by pulling it outwards.
3. Wash all the components thoroughly with hot water and mild dish soap. All components can be washed in a dishwasher, placing them in the top basket of the dishwasher. Make sure there are no milk residues left inside the holes and the groove on the fine end of the selector.
4. Check that the intake tube and spout are not clogged with milk residues.
5. Replace the selector, milk spout and intake tube.
6. Replace the lid on the milk container, turning it counterclockwise to hook it in place.

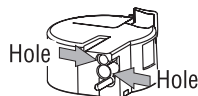
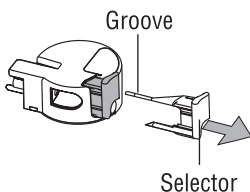
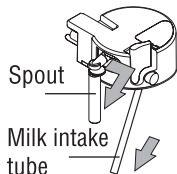

DESCALING

Descal the machine when the message "DESCALE!" flashes on the LCD display.

! **Important!** Descaler contains acids which may irritate the skin and eyes. It is vital to adhere to the manufacturer's safety warnings given on the descaler pack and the warnings relating to the procedure to follow in the event of contact with the skin and eyes.

i **Information!** Use De'Longhi recommended descaler only. Under no circumstances should you use sulphamic or acetic based descalers. Their use invalidates the warranty. Failure to descale the appliance as described above also invalidates the warranty.

1. Turn the machine on.
2. Enter the programming menu by pressing the **P** icon.
3. Press the **◀** or **▶** icon until "Descaling" is displayed.
4. Select by pressing the **OK** icon. "Descaling Confirm?" is displayed. Press OK to activate the function.
5. The message "Add descaler. Confirm?" is displayed.
6. Before confirming, empty the water tank (A13).
Pour the descaler diluted with water (respecting the proportions indicated on the descaler bottle) into the water tank. Place an empty container with a minimum capacity of 50 oz (1.5 L) under the hot water spout.

! **Important! Danger di of burns** Hot water containing descaler flows out of the hot water spout. Avoid contact with splashes of water.

7. Confirm by pressing the **OK** icon.
8. The message "Descaling Underway..." is displayed. The descaling program starts and the descaler liquid comes out of the water spout.

The descale program automatically performs a series of rinses and pauses to remove limescale deposits from inside the machine. After about 30 minutes, the message "Rinsing FILL TANK!" is displayed.

9. The appliance is now ready for rinsing through with clean water.
Remove the water tank, empty, rinse under running water, fill with clean water and replace. "Rinsing... Press OK" is displayed.
10. Empty the container used to collect the descaler solution and replace it under the hot water spout.
11. Press the **OK** icon to start rinsing. Hot water flows out of the spout and the message "Rinsing..." is displayed.
12. When the water tank is completely empty, the message "Rinsing complete... Press OK" is displayed.
13. Press the **OK** icon, fill the water tank and the appliance is ready for use.

SETTING WATER HARDNESS

The DESCAL message is displayed after a period of time established according to water hardness.

The machine is factory set for a hardness value of 4 (very hard water).

The machine can also be programmed according to the actual hardness of the tap water in the various regions, varying the frequency with which the message is displayed.

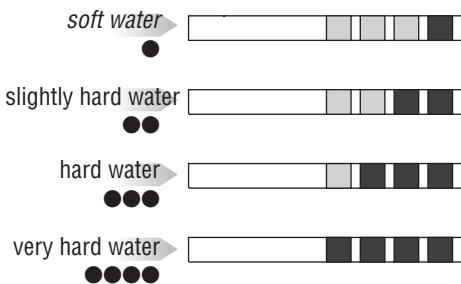

Measuring water hardness

1. Remove the "TOTAL HARDNESS TEST" indicator paper from its pack.
2. Immerse the paper completely in a glass of water for about a second.
3. Remove the paper from the water and shake lightly.
After about a minute, 1, 2, 3, or 4 red squares form, depending on the hardness of the water. Each square corresponds to one level.

Setting water hardness

1. Press the **P** icon to enter the programming menu.
2. Press the ◀ or ▶ icon and select "Water hardness".
3. Confirm the selection by pressing the **OK** icon.
4. Press the ◀ or ▶ icon to set the number of squares formed on the reactive strip (see figure in the previous section).
5. Press the **OK** icon to confirm the setting.
6. Press the **ESC** icon to exit the menu.

The machine is now reprogrammed with the new water hardness setting.

USING COMPARTMENT FOR LATTE GLASS

To accommodate larger latte cups under the coffee spouts, lift compartment door (A17) towards machine and place glass in compartment.

DISPLAYED MESSAGES

DISPLAYED MESSAGE	POSSIBLE CAUSE	REMEDY
FILL TANK!	<ul style="list-style-type: none"> The water tank is empty or positioned incorrectly. 	<ul style="list-style-type: none"> Fill the tank with water and/or insert it correctly, pushing it as far as it will go.
GROUND TOO FINE ADJUST MILL! Insert water spout and press OK	<ul style="list-style-type: none"> The grinding is too fine and the coffee is delivered too slowly. 	<ul style="list-style-type: none"> Make the coffee again and turn the grinding adjustment knob one click clockwise towards "7" while the coffee mill is in operation. The effect is only visible after delivering two coffees.
	<ul style="list-style-type: none"> The machine cannot make coffee as there is air in the hydraulic circuit 	<ul style="list-style-type: none"> Press the OK icon to deliver water from the spout until it flows out normally.
INSERT WATER SPOUT!	<ul style="list-style-type: none"> The water spout is not inserted or is inserted incorrectly. 	<ul style="list-style-type: none"> Insert water spout as far as it will go.
EMPTY GROUNDS CONTAINER	<ul style="list-style-type: none"> The grounds container is too full or more than 3 days have passed since you last made coffee (this guarantees correct hygiene of the machine). 	<ul style="list-style-type: none"> Empty the grounds container and clean, then replace. Important: when removing the drip tray, the grounds container MUST be emptied, even if it is not completely full. If this is not done, when you make the next coffees, the grounds container may fill up more than expected and clog the machine.
INSERT GROUNDS CONTAINER	<ul style="list-style-type: none"> After cleaning, the grounds container has not been replaced. 	<ul style="list-style-type: none"> Open the service door and insert the grounds container. If grounds container is inside the machine and message is still displayed, there may be a damaged microswitch and customer service should be called.
INSERT MILK CONTAINER!	<ul style="list-style-type: none"> The milk container is not inserted. . 	<ul style="list-style-type: none"> Insert milk container as far as it will go.
DESCALE!	<ul style="list-style-type: none"> The machine must be descaled. 	<ul style="list-style-type: none"> The descaling procedure described in the "Descaling" section needs to be performed as soon as possible.
LESS COFFEE!	<ul style="list-style-type: none"> Too much ground coffee has been used. 	<ul style="list-style-type: none"> Select a milder taste or reduce the quantity of pre-ground coffee, then make the coffee again.
ADD PRE-GROUND COFFEE!	<ul style="list-style-type: none"> The "pre-ground coffee" function has been selected without placing any pre-ground coffee in the funnel. 	<ul style="list-style-type: none"> Place pre-ground coffee in the funnel.
	<ul style="list-style-type: none"> The funnel (A8) is blocked. 	<ul style="list-style-type: none"> Empty the funnel with the help of a dull knife, as described in the section "Cleaning the pre-ground coffee feed funnel".
FILL BEANS CONTAINER!	<ul style="list-style-type: none"> The coffee beans have run out. 	<ul style="list-style-type: none"> Fill bean container
INSERT BREW GROUP ASSEMBLY!	<ul style="list-style-type: none"> The brew group has not been replaced after cleaning. 	<ul style="list-style-type: none"> Insert the brew group as described in the section "Cleaning the brew group".
CLOSE DOOR!	<ul style="list-style-type: none"> The service door is open 	<ul style="list-style-type: none"> Close the service door.

DISPLAYED MESSAGE	POSSIBLE CAUSE	REMEDY
GENERAL ALARM!	<ul style="list-style-type: none"> The inside of the appliance is very dirty. 	<ul style="list-style-type: none"> Clean the inside of the appliance thoroughly as described in the section "Cleaning the inside of the machine". If the message is still displayed after cleaning, contact customer services.
PRESS CLEAN BUTTON	<ul style="list-style-type: none"> Milk has been delivered recently and the tubes inside the milk container must be cleaned. 	<ul style="list-style-type: none"> Press the CLEAN button and keep it pressed until the progress bar which appears on the display together with the message "Cleaning" is complete.
ADD PRE-GROUND COFFEE! PRESS OK	<ul style="list-style-type: none"> The appliance is delivering a LONG coffee of more than 4.2 oz (125 ml). 	<ul style="list-style-type: none"> Add a level measure of pre-ground coffee and confirm by pressing the OK icon.

TROUBLESHOOTING

Below is a list of some of the possible malfunctions.

If the problem cannot be resolved as described, contact customer service.

PROBLEM	POSSIBLE CAUSE	REMEDY
The coffee is not hot	<ul style="list-style-type: none"> The cups have not been preheated. 	<ul style="list-style-type: none"> Warm the cups by rinsing them with hot water.
	<ul style="list-style-type: none"> The brew group has cooled down because 2-3 minutes have elapsed since the last coffee was made. 	<ul style="list-style-type: none"> Before making coffee, rinse as described in the notes in the section "Preparing coffee using coffee beans".
The coffee is not creamy enough	<ul style="list-style-type: none"> The coffee is ground too coarsely. 	<ul style="list-style-type: none"> Turn the grinding adjustment knob one click counterclockwise towards "1" while the coffee mill is in operation (fig. 11). Continue one click at a time until coffee delivery is satisfactory. The effect is only visible after delivering two coffees.
	<ul style="list-style-type: none"> Wrong type of coffee. 	<ul style="list-style-type: none"> Use a type of coffee for espresso coffee makers.
The coffee is delivered too slowly or a drop at a time.	<ul style="list-style-type: none"> The coffee is ground too finely. 	<ul style="list-style-type: none"> Turn the grinding adjustment knob one click clockwise towards "7" while the coffee mill is in operation (fig. 11). Continue one click at a time until coffee delivery is satisfactory. The effect is only visible after delivering two coffees.
The coffee is delivered too quickly.	<ul style="list-style-type: none"> The coffee is ground too coarsely. 	<ul style="list-style-type: none"> Avoid turning the grinding coarseness regulator excessively otherwise when you select two cups, the coffee may be delivered a drop at a time. The effect is only visible after delivering two coffees.
Coffee does not come out of one of the spouts.	<ul style="list-style-type: none"> The spouts are blocked. 	<ul style="list-style-type: none"> Clean the spouts with a toothpick (fig. 39).
The coffee does not come out of the spouts, but from around the service door (A19).	<ul style="list-style-type: none"> The holes in the spouts are clogged with dry coffee dust. 	<ul style="list-style-type: none"> Clean the spouts with a toothpick, sponge or hard bristled kitchen brush.
	<ul style="list-style-type: none"> The coffee guide (A21) inside the service door is blocked and cannot swing. 	<ul style="list-style-type: none"> Thoroughly clean the coffee guide (A21), particularly near the hinges.

PROBLEM	POSSIBLE CAUSE	REMEDY
The milk contains bubbles or squirts out of the milk spout	<ul style="list-style-type: none"> The milk is not cold enough or is not semi-skimmed. 	<ul style="list-style-type: none"> You should ideally use skimmed or semi-skimmed milk at refrigerator temperature (about 41°F). If the result is still disappointing, try another brand of milk.
	<ul style="list-style-type: none"> The milk frother selector is incorrectly adjusted. 	<ul style="list-style-type: none"> Adjust following the instructions in the section on preparing drinks with milk.
	<ul style="list-style-type: none"> The milk container lid is dirty. 	<ul style="list-style-type: none"> Clean the milk container lid as described in the section "Cleaning the milk container".
The appliance does not come on.	<ul style="list-style-type: none"> It is not plugged into the power outlet. 	<ul style="list-style-type: none"> Plug into the power outlet.
The LONG coffee has too much froth.	<ul style="list-style-type: none"> The coffee is ground too fine. 	<ul style="list-style-type: none"> Turn the grinding adjustment knob one click clockwise towards "7" while the coffee mill is in operation (fig. 11). Continue one click at a time until coffee delivery is satisfactory. The effect is only visible after delivering two coffees.

This warranty applies to Super Automatic Espresso Machines with the De'Longhi brand name.

LIMITED WARRANTY

What does the warranty cover?

We warrant each appliance to be free from defects in material and workmanship. Our obligation under this warranty is limited to repair at our factory or authorized service center of any defective parts or part thereof, other than parts damaged in transit. The repaired or new model will be returned at the company expense.

This warranty shall apply only if the appliance is used in accordance with the factory directions, which accompany it, and on an alternating current (AC) circuit.

How long does the coverage last?

This warranty runs for two years (2) from the purchase date found on your receipt and applies only to the original purchaser for use.

What is not covered by the warranty?

The warranty does not cover defects or damage of the appliance, which result from repairs or alterations to the appliance outside our factory or authorized service centers, nor shall it apply to any appliance, which has been subject to abuse, misuse, negligence or accidents. Also, consequential and incidental damage resulting from the use of this product or arising out of any breach of contract or breach of this warranty are not recoverable under this warranty. Some states do not allow the exclusion or limitation of incidental or consequential damage, so the above limitation may not apply to you.

How do you get service?

If repairs become necessary, see contact information below:

U.S. Residents:

Please contact our toll free hotline at 1-866-528-8323 (1-866-Latte-Best) or log onto our website at www.delonghi.com.

For all accessories, spare parts or replacement parts, please contact our parts division at 1-800-865-6330.

Residents of Canada:

Residents of Canada: Please contact our toll free hotline at 1-888-335-6644 or log onto our website at www.delonghi.com.

Residents of Mexico:

Please refer to the Limited Warranty statement for Mexico (see page 63).

Please refer to the back page of the manual for De'Longhi addresses.

The above warranty is in lieu of all other express warranties and representations. All implied warranties are limited to the applicable warranty period set forth above. This limitation does not apply if you enter into an extended warranty with De'Longhi. Some states do not allow limitations on how long an implied warranty lasts, so the above exclusions may not apply to you. De'Longhi does not authorize any other person or company to assume for it any liability in connection with the sale or use of its appliance.

How does state law apply?

This warranty gives you specific legal rights, and you may also have other rights, which vary from state to state